



Horizontální monobloková odstředivá čerpadla

MD

$Q_{max} = 60 \text{ l/s}$

$H_{max} = 85 \text{ m}$

$P_{max} = 18,5 \text{ kW}$

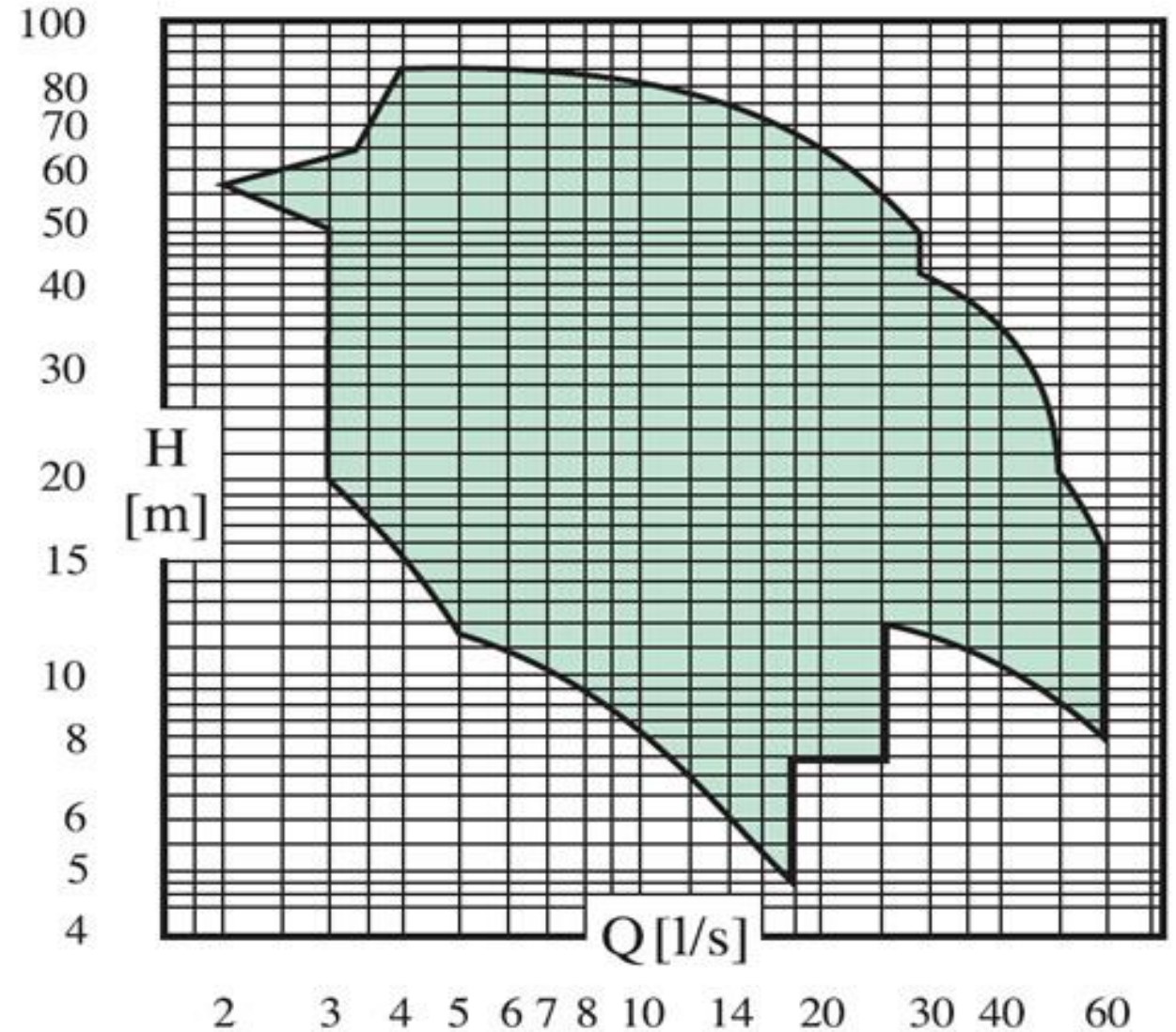

Vertikální článková monobloková odstředivá čerpadla

CVX

Qmax= 12 l/s
Hmax= 260 m
Pmax= 30 kW

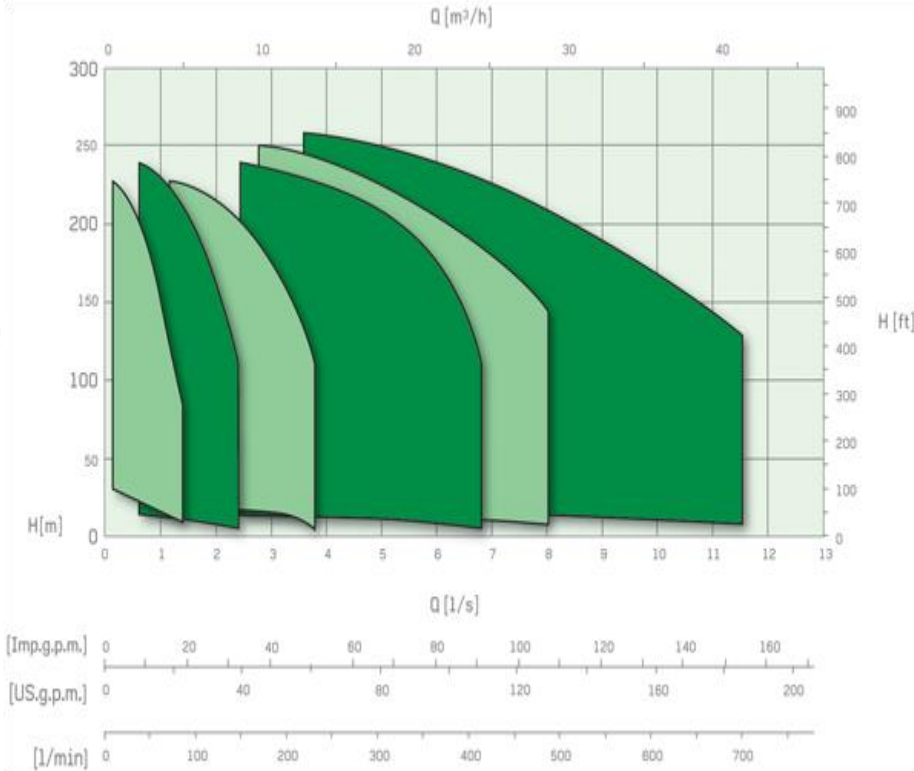

HV

Qmax= 50 l/s
Hmax= 250 m
Pmax= 90 kW

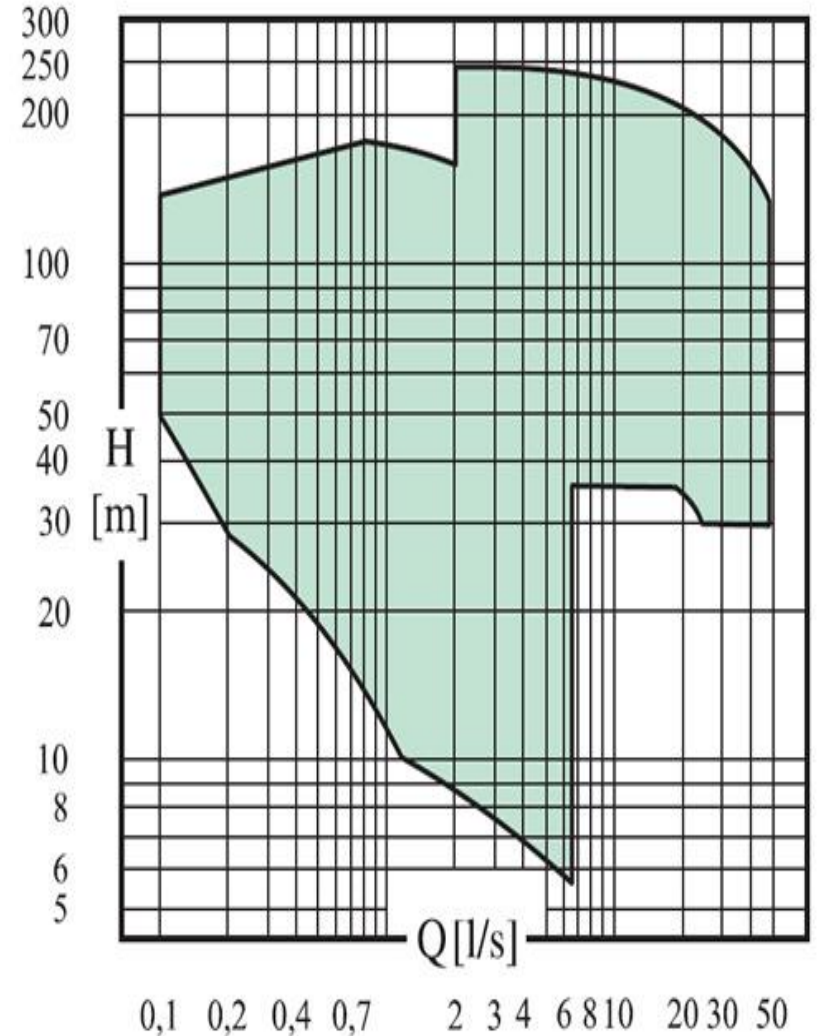

Horizontální članková odstředivá čerpadla

HMU

$Q_{max} = 26 \text{ l/s}$

$H_{max} = 280 \text{ m}$

$P_{max} = 55 \text{ kW}$

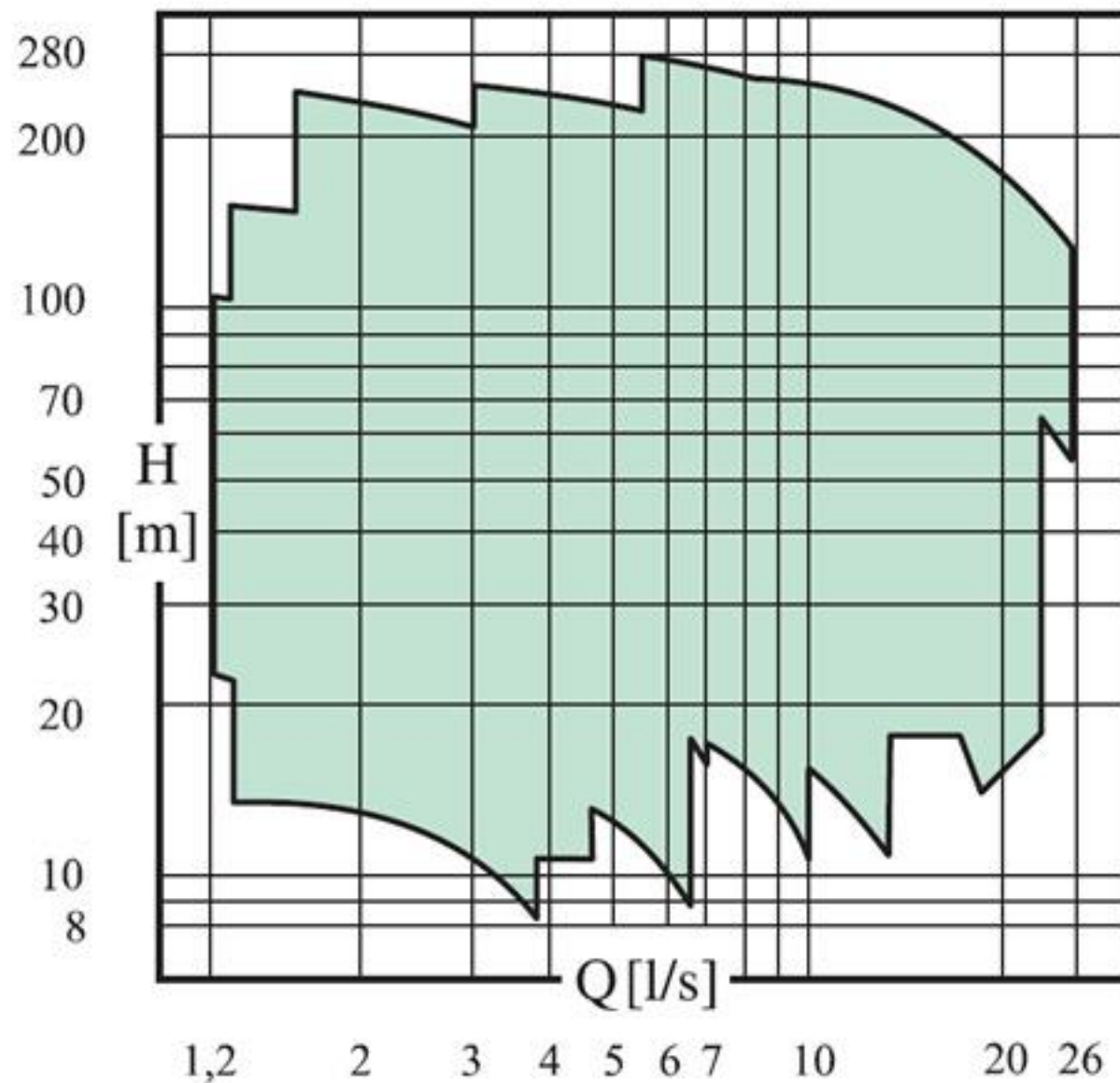

Nerezová oběžná kola

Vysokotlaká článková odstředivá čerpadla

PM, PMXT

Q_{max}= 160 l/s
H_{max}= 1000 m
P_{max}= 650 kW

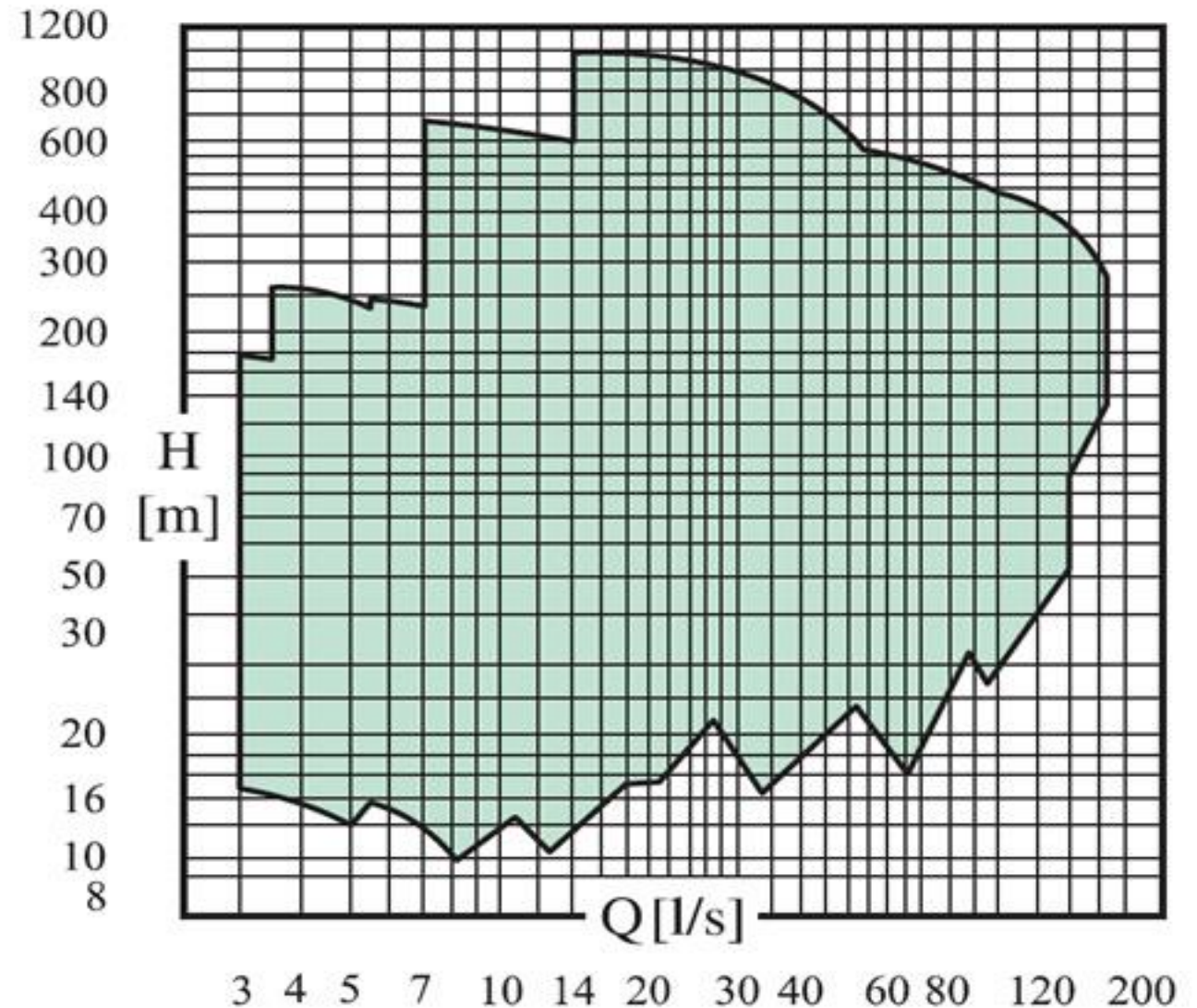
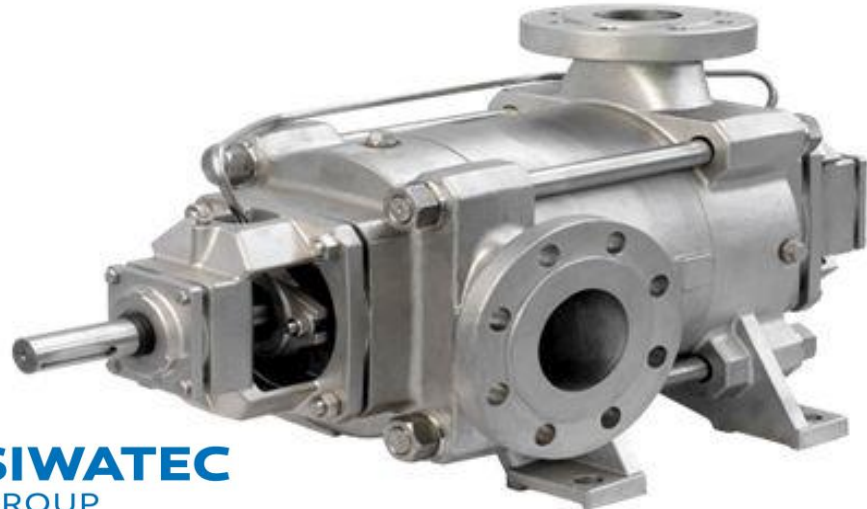

Robustní ložiska, hydraulický vyrovnávací systém.

MEC A

Q_{max}= 130 l/s
H_{max}= 140 m
P_{max}= 132 kW

MEC MR

Q_{max}= 100 l/s
H_{max}= 210 m
P_{max}= 132 kW

MEC D

Q_{max}= 14 l/s
H_{max}= 17 m
P_{max}= 12 kW



Možnost mechanické ucpávky nebo měkké ucpávky.



MEC AG

Qmax= 130 l/s
Hmax= 110 m



MEC MG

Qmax= 100 l/s
Hmax= 185 m
Pmax= 132 kW

Čerpadla pro pohon spalovacím motorem.

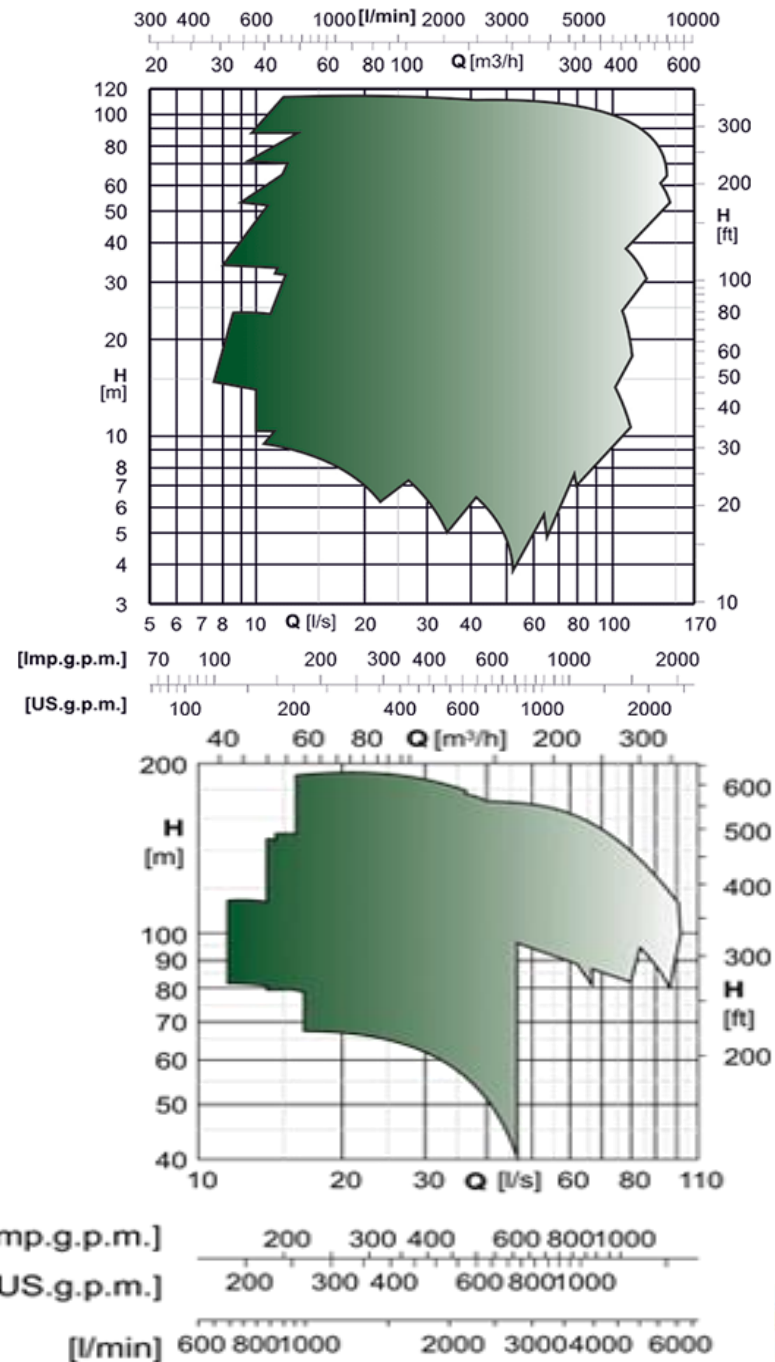

Horizontální kozlíková odstředivá čerpadla

NC

Qmax= 430 l/s
 Hmax= 160 m
 Pmax= 355 kW



Čerpadla splňující normu EN 733

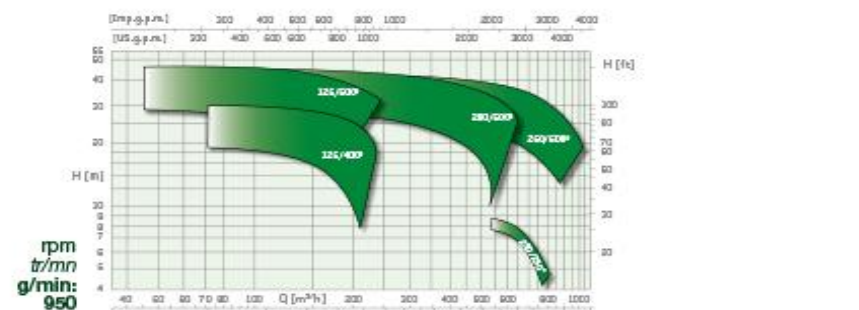
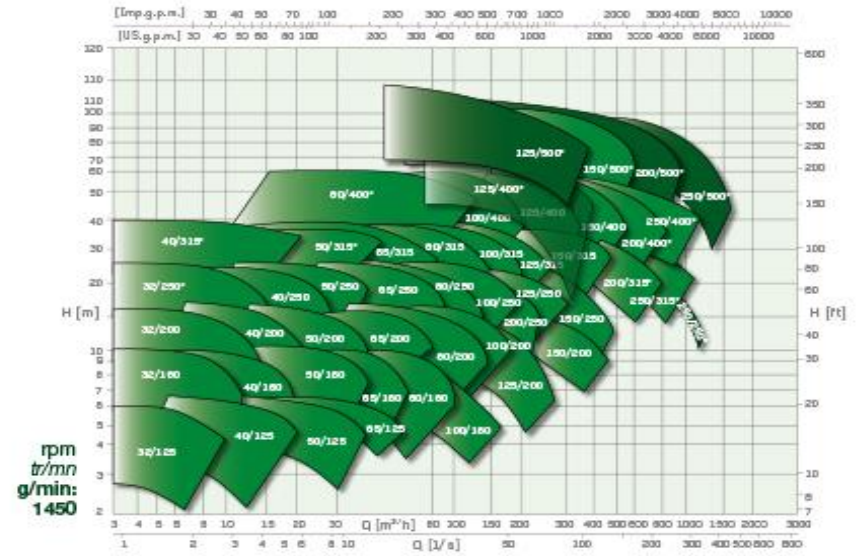
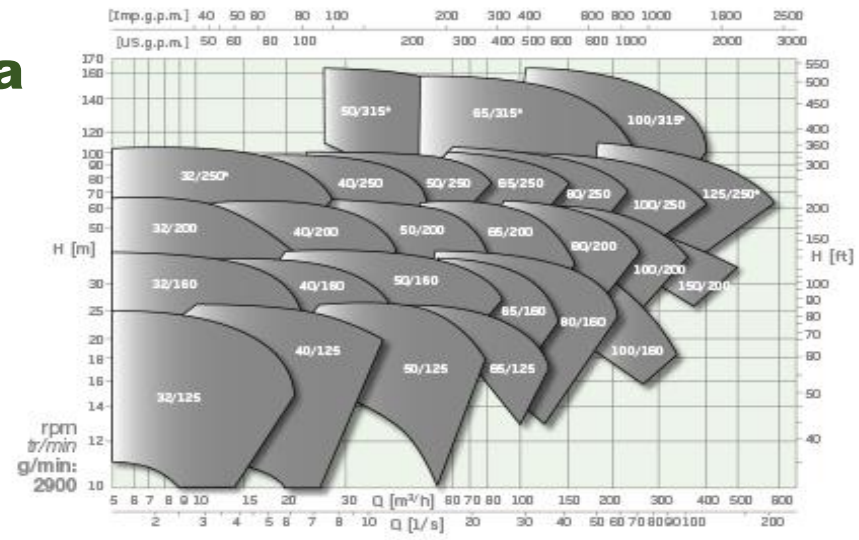

Horizontální jednostupňová odstředivá čerpadla

BHR

$Q_{\max} = 280 \text{ l/s}$

$H_{\max} = 25 \text{ m}$

$P_{\max} = 37 \text{ kW}$

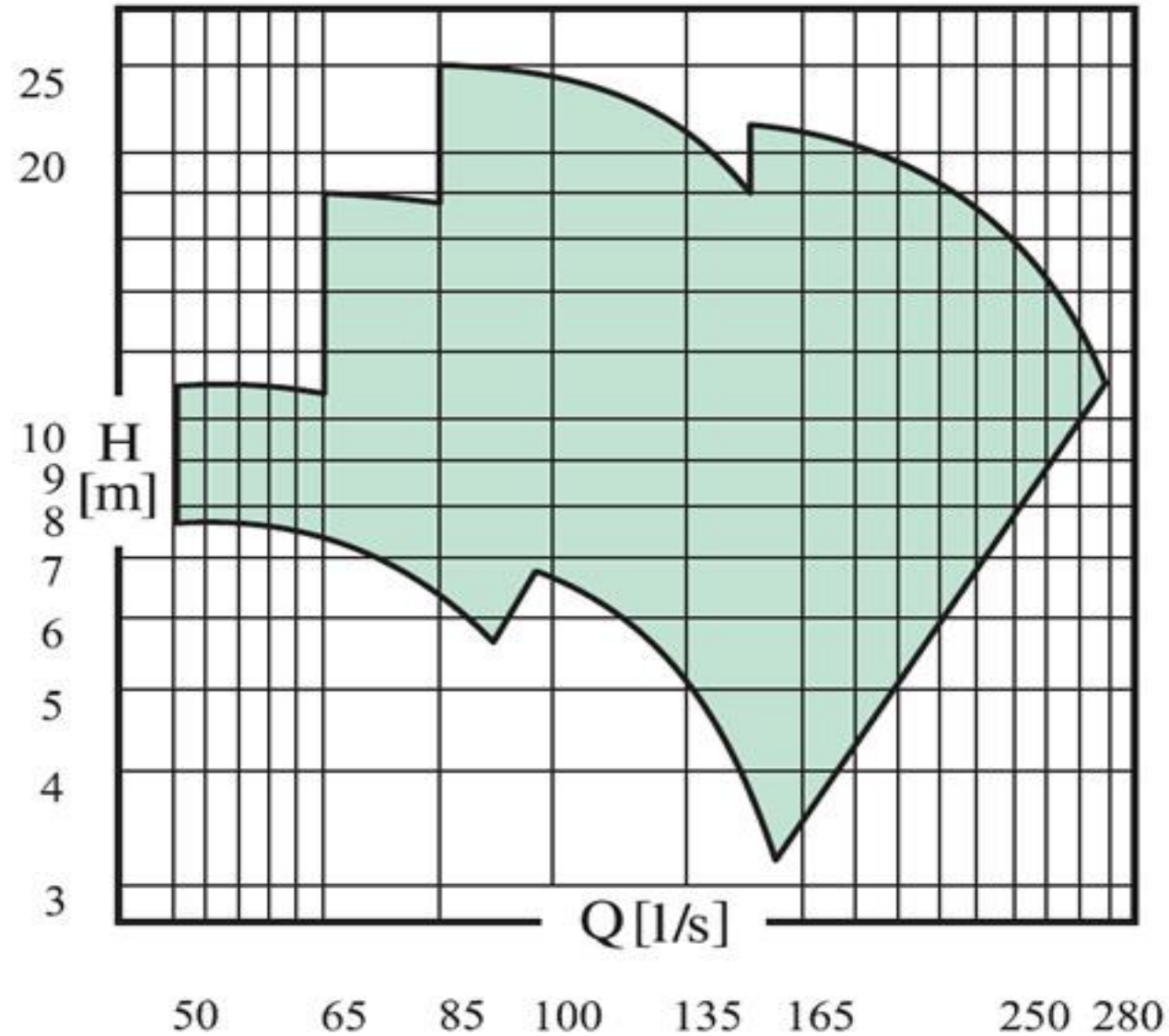

Čerpadla pro pohon 6 pólovým nebo 4 pólovým elektromotorem nebo spalovacím motorem.

Odstředivá čerpadla s děleným tělesem (split case)

SCC

Q_{max}= 780 l/s

H_{max}= 150 m

P_{max}= 1120 kW

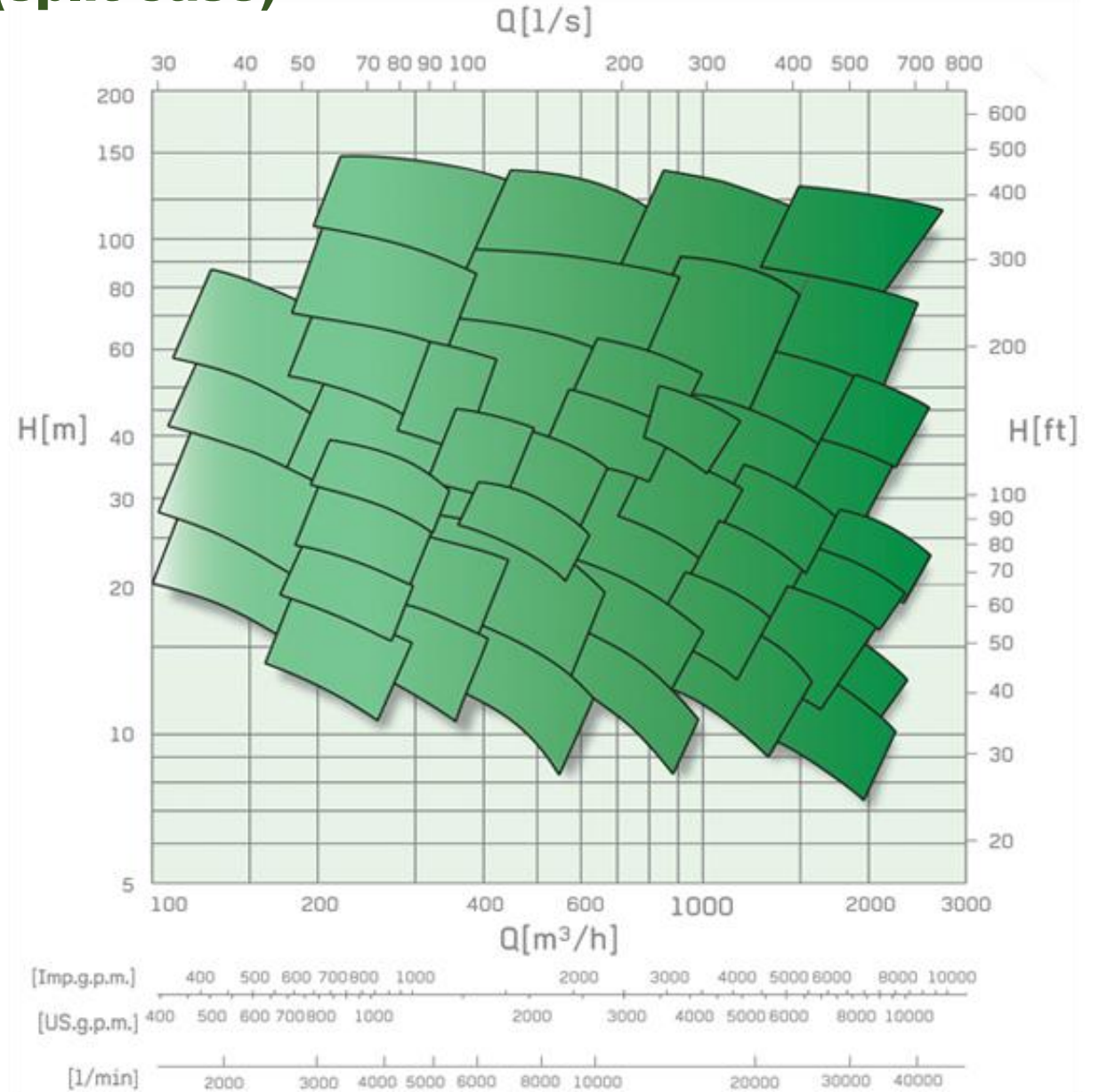

Vertikální članková čerpadla s ponořenou hydraulikou

P6, P18

Q_{max}= 400 l/s
 H_{max}= 250 m
 P_{max}= 400 kW

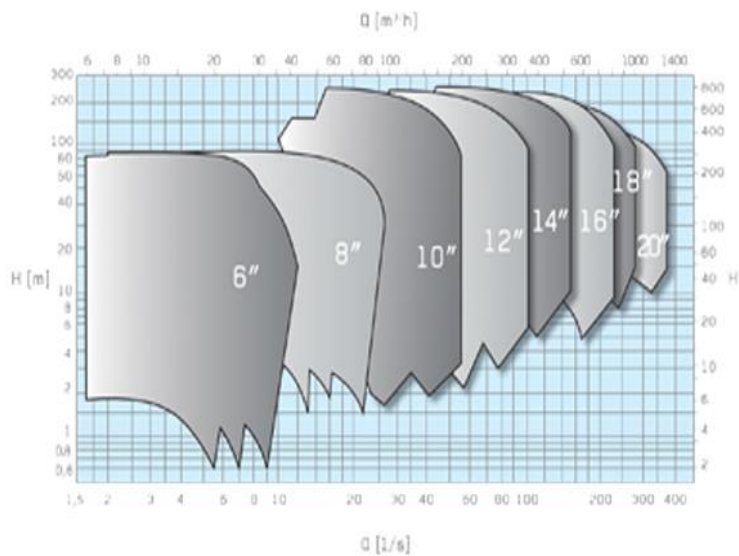
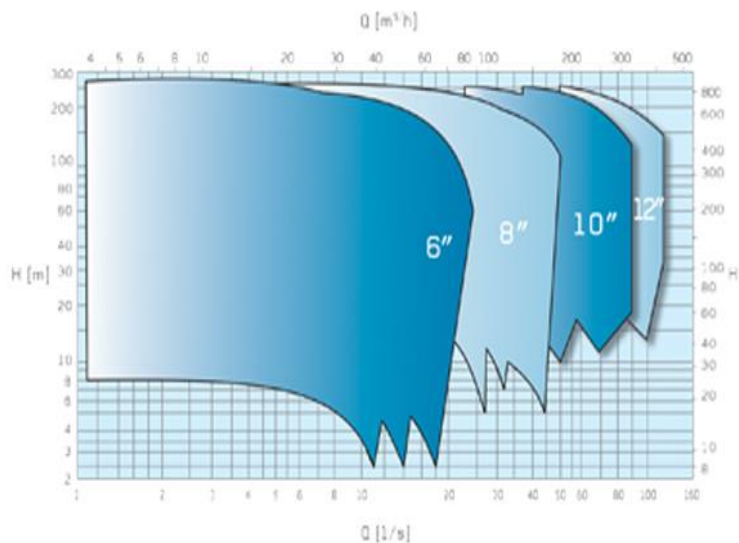

P6P, P8P

Q_{max}= 50 l/s
 H_{max}= 220 m
 P_{max}= 92 kW

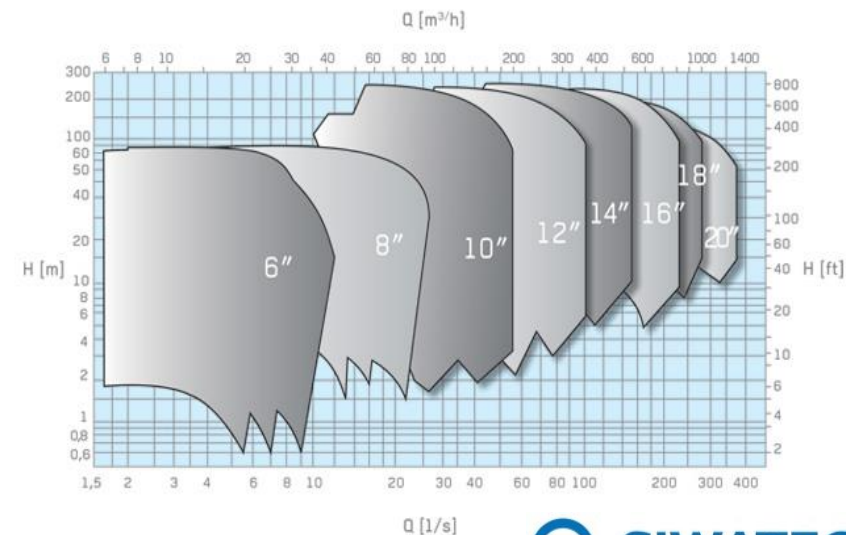
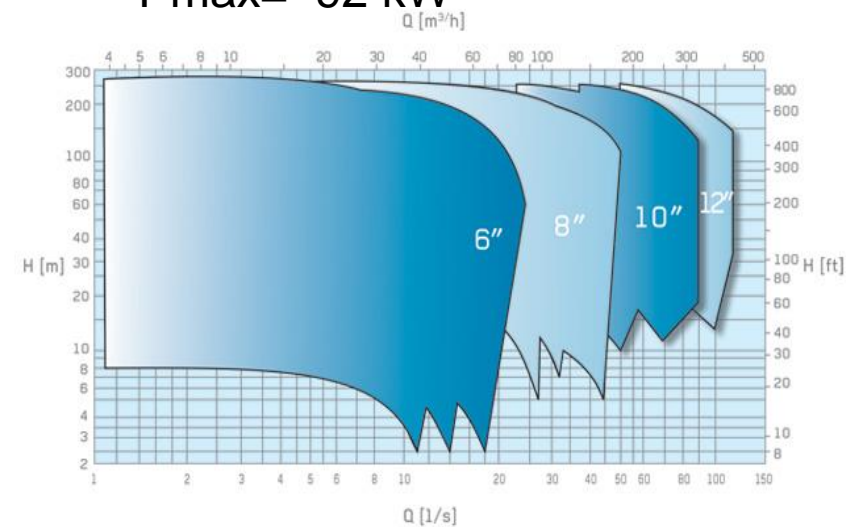

OXY-FLOW aeratory

$P_{max} = 25 \text{ kW}$

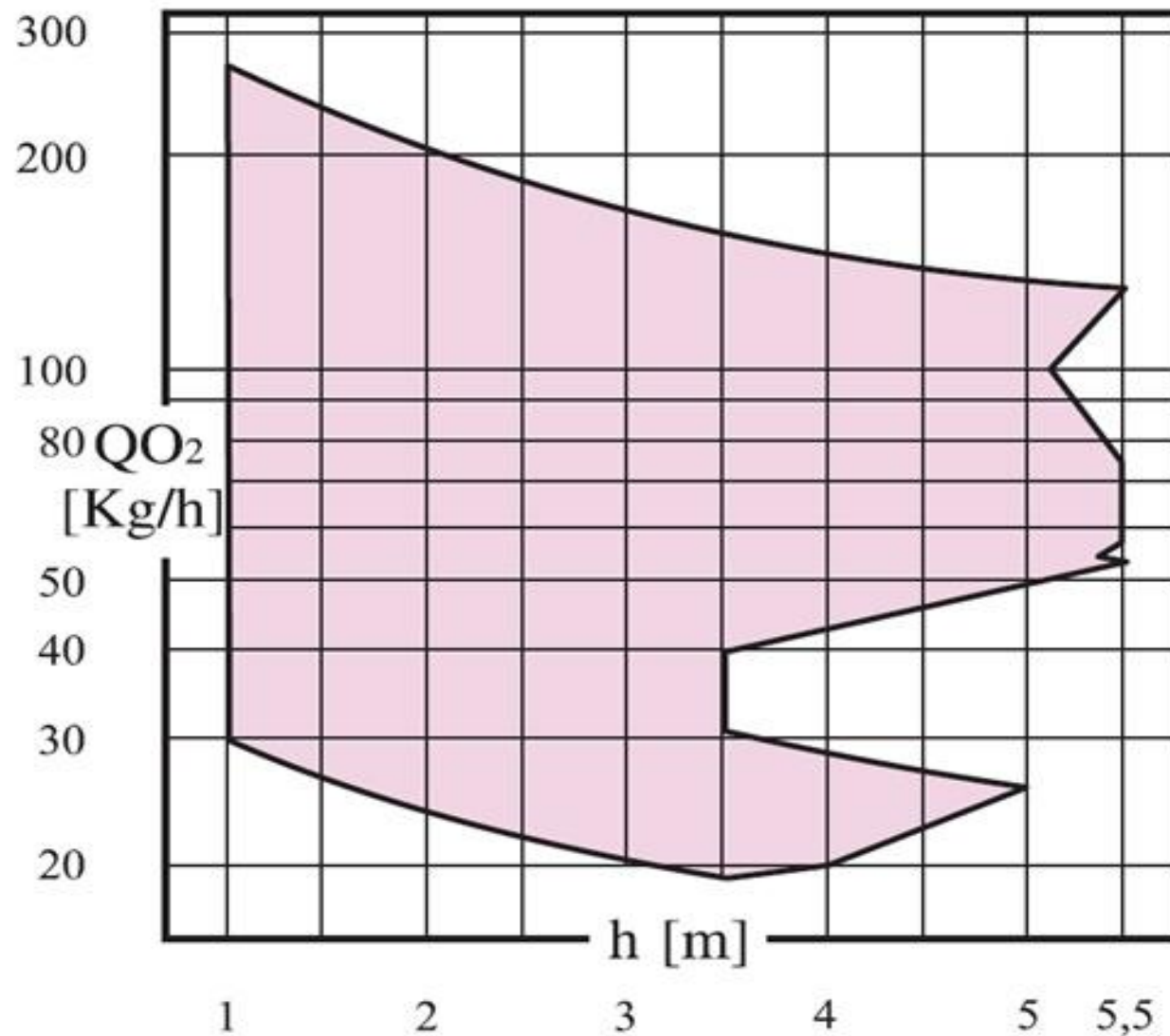

CMD míchadla

Qmax= 316 l/s

Pmax= 3 kW

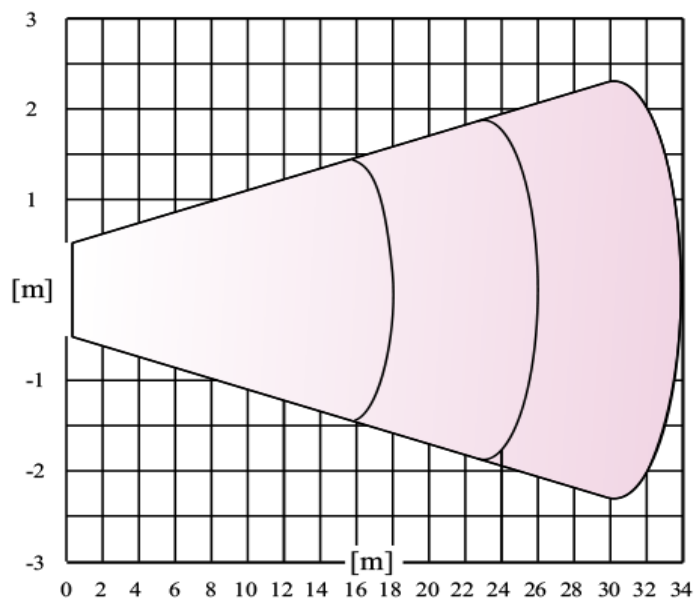

CMR míchadla

Qmax= 1860 l/s

Pmax= 18,5 kW

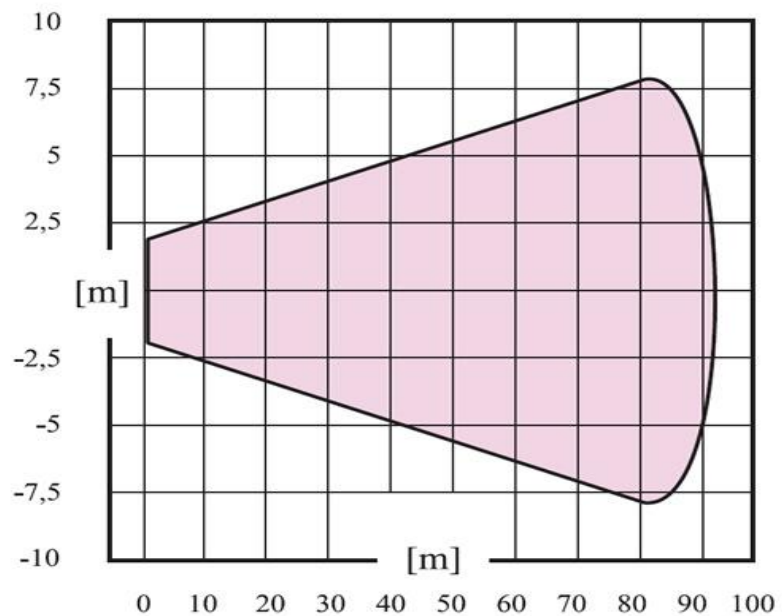

CMB míchadla

Qmax= 4890 l/s

Pmax= 4 kW

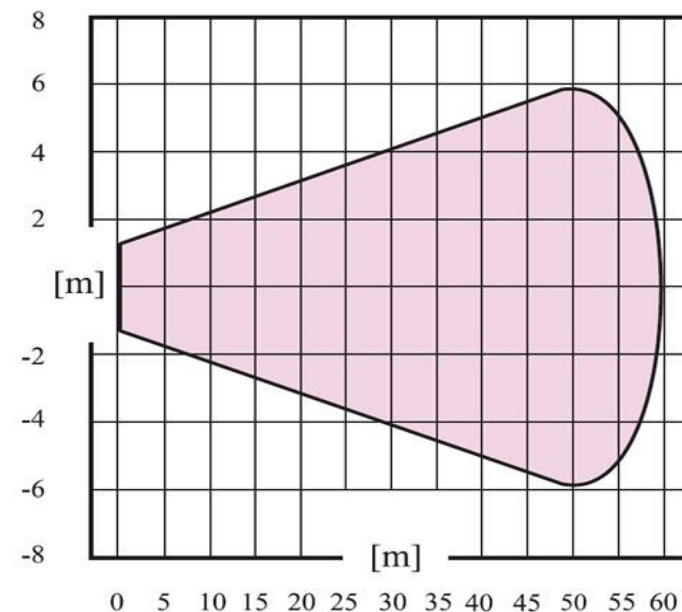

Nerezová ponorná článková čerpadla do vrtů 4“, 6“ s radiálními oběžnými koly

E4X, E6X

Q_{max}= 7,5 l/s

H_{max}= 400 m

P_{max}= 7,5 kW



4 pollici 50 Hz

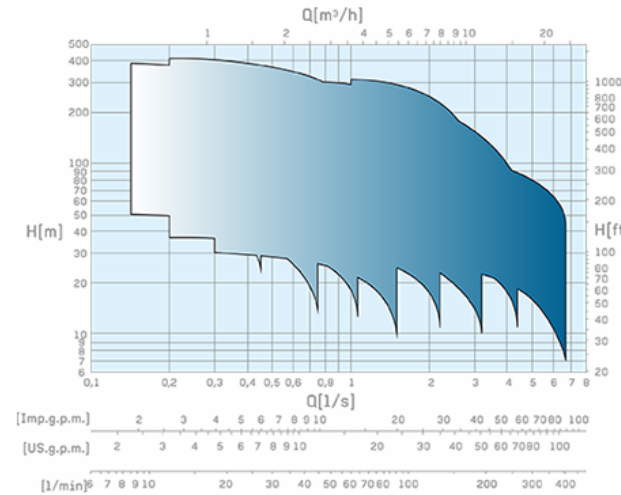

4 pollici 60 Hz

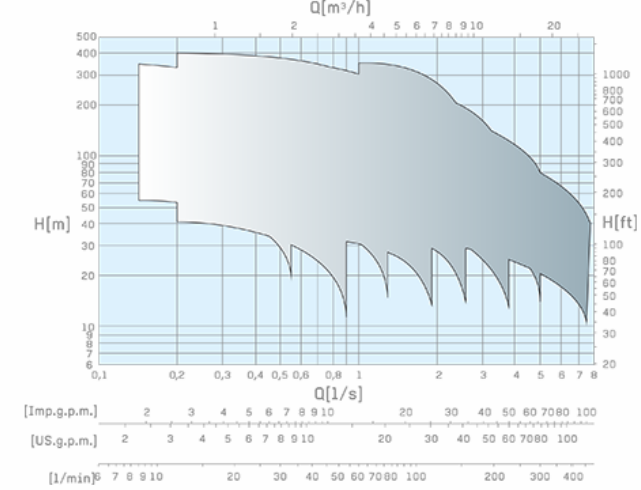

6 pollici 50 Hz

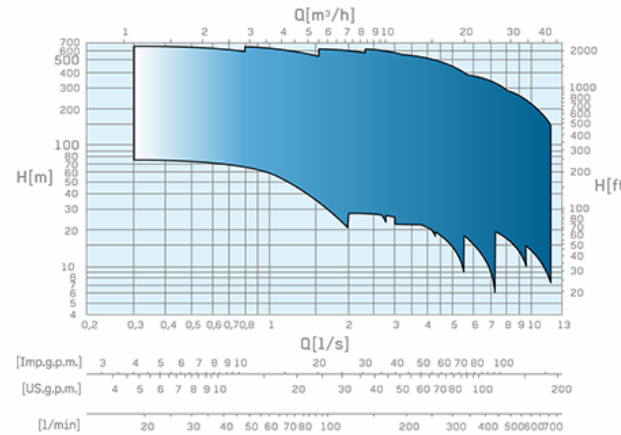

6 pollici 60 Hz

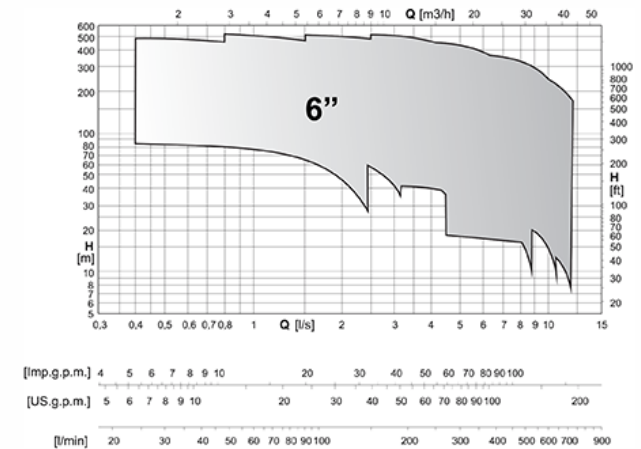

Obsah písku až 300g/m³ (patentovaný SAND OUT SYSTEM)

Ponorná članková čerpadla do vrtů 6“, 8“ s diagonálními oběžnými koly

E6P, E8P

Q_{max}= 48 l/s

H_{max}= 460 m

P_{max}= 92 kW

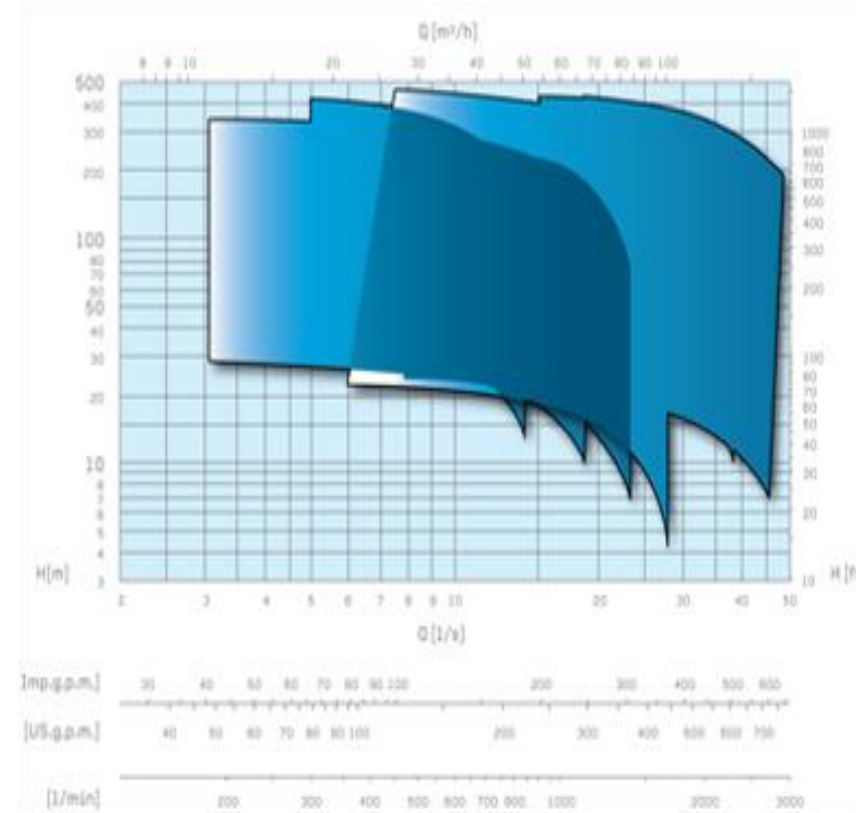

Ponorná članková čerpadla do vrtů 8“, 10“ s radiálními oběžnými koly

E8R, E10R

Q_{max}= 37 l/s

H_{max}= 770 m

P_{max}= 170 kW

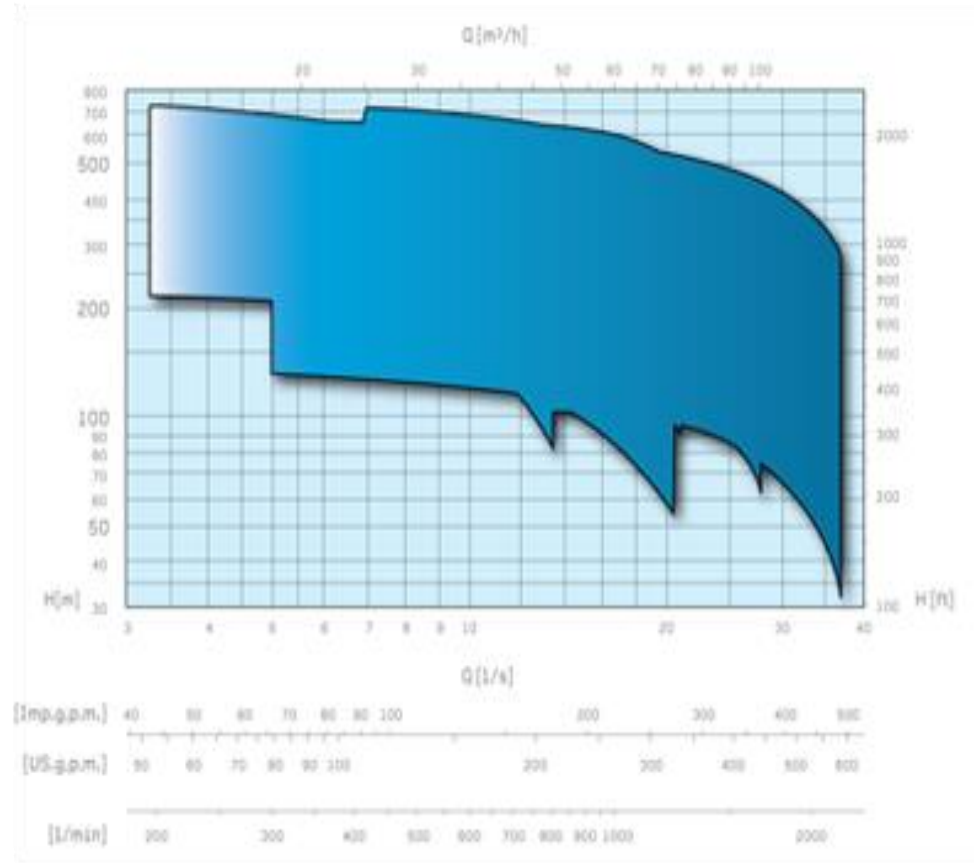

Ponorná článková čerpadla do vrtů 10“,12“,14“,16“,18“, 20“,22“ s diagonálními oběžnými koly

E10S, E12S, E14S, E16S, E18S

Q_{max}= 250 l/s
H_{max}= 600 m
P_{max}= 370 kW

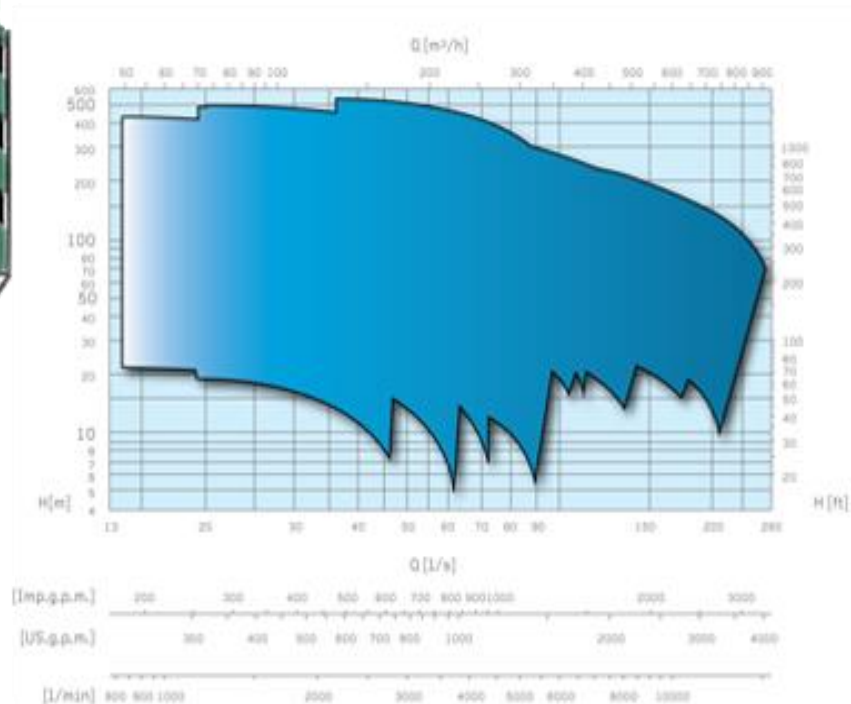

E20S, E22S

Q_{max}= 30 l/s
H_{max}= 130 m
P_{max}= 240 kW

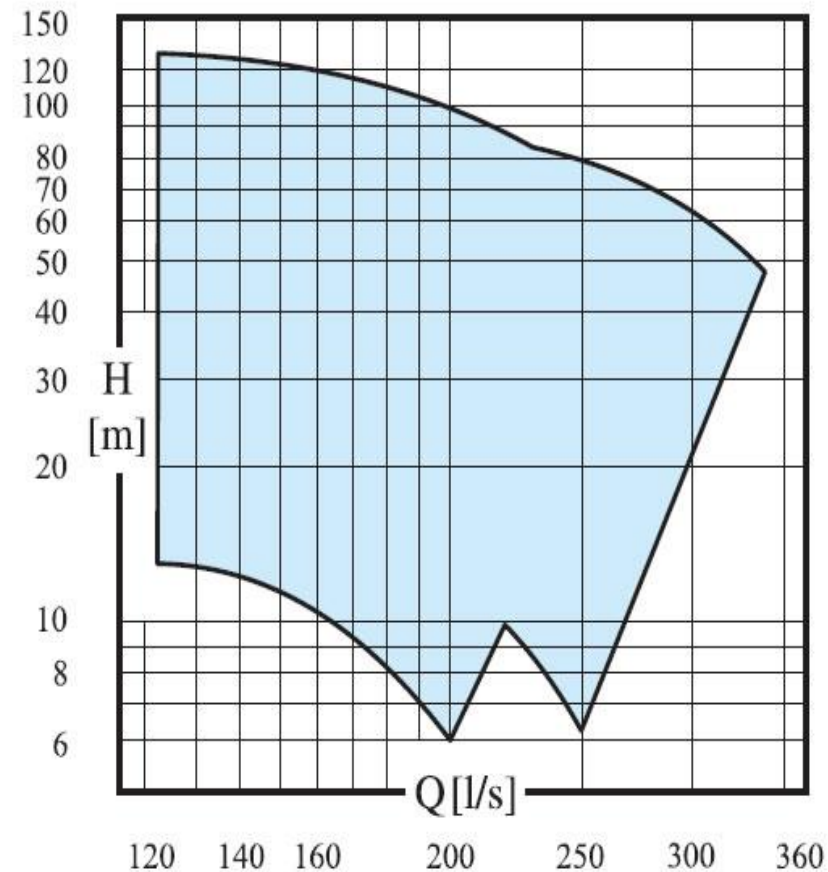

Čerpadla pro pohon 2 pólovým nebo 4 pólovým elektromotorem.

Nerezová ponorná članková čerpadla 6“,8“,10“ s diagonálními/radiálními oběžnými koly

E6RX, E6SX, E8PX, E10PX

Q_{max}= 45 l/s

H_{max}= 850 m

P_{max}= 92 kW

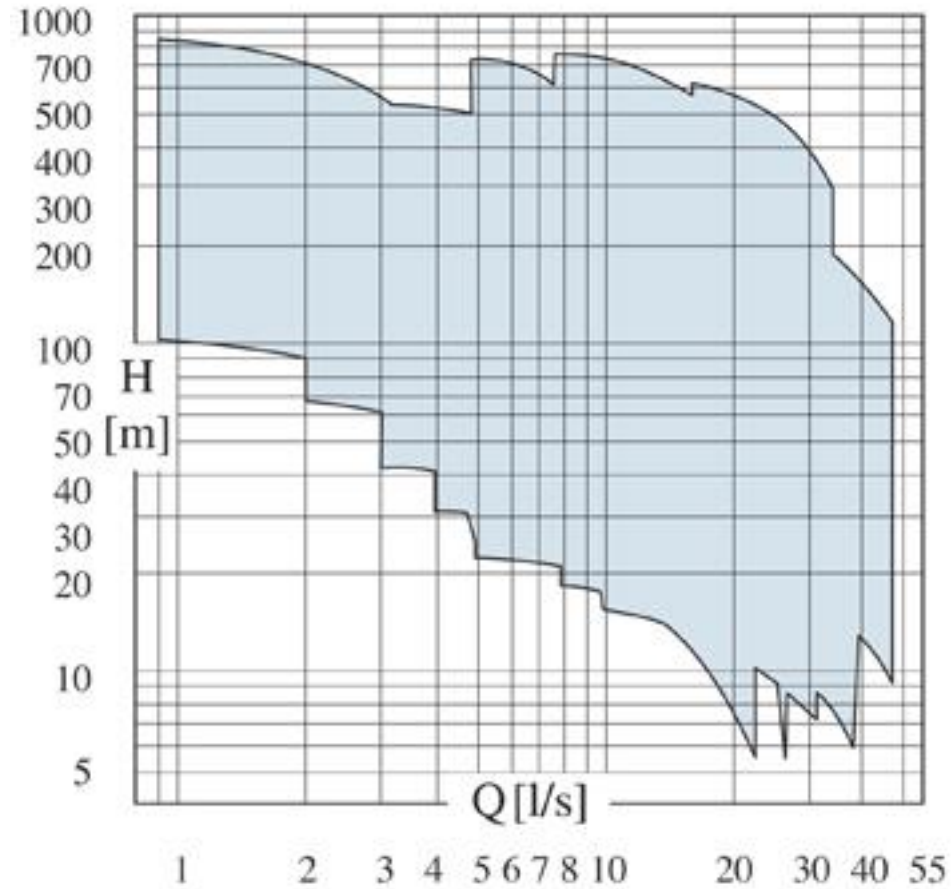

caprari
Reliable future of water. Since 1945

Robustní celonerezová hydraulika čerpadla.

SIWATEC

čerpadla | pumps

30^{let}
SIWATEC

SIWATEC
GROUP

ABO valve

AQUA
INDUSTRIAL

30
LET
ZKUŠENOSTÍ
1991-2021



caprari
pumping power

