

Výrobce ponorných článkových čerpadel do vrtů 4", 6", 8", 10" a 12".







6" 140 PR 140 PRX

PANELLI



MADE IN ITALY

**Max. průtok: 48 m³/h
Max. dopravní výška: 630 m
Max. obsah písku: 400 g/m³
Max. výkon: 37 kW**



140 PR

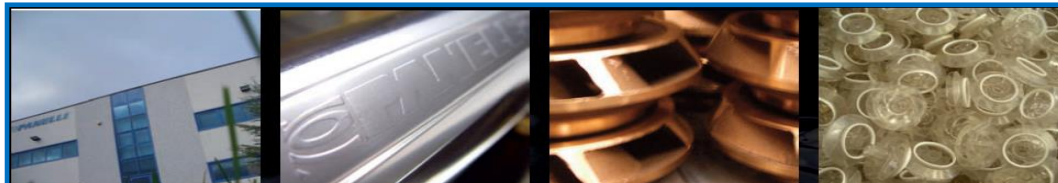

SIWATEC



6" 8" 10"

140 REC
180 REC
230 REC

PANELLI



MADE IN ITALY

Max. průtok: 300 m³/h
Max. dopravní výška: 450 m
Max. obsah písku: 50 g/m³
Max. výkon: 147 kW



140 REC 180 REC 230 REC

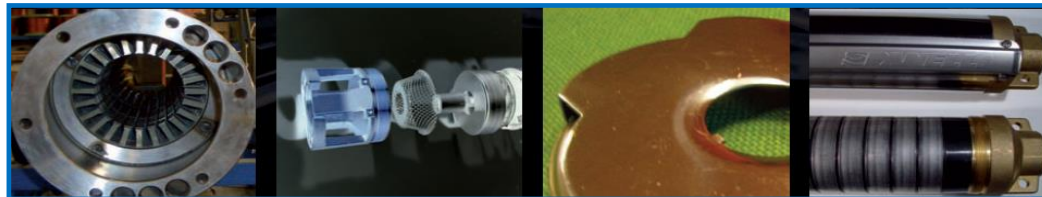

SIWATEC

6" 8" 140 RX 180 RX



MADE IN ITALY

Max. průtok: 78 m³/h
Max. dopravní výška: 620 m
Max. obsah písku: 50 g/m³
Max. výkon: 75 kW



140 RX



180 RX





6" 8" 10"

140 SX
180 SX
230 SX

PANELLI®



MADE IN ITALY

Max. průtok: 348 m³/h
Max. dopravní výška: 470 m
Max. obsah písku: 50 g/m³
Max. výkon: 220 kW



140 SX 180 SX 230 SX



SIWATEC

ELEKTROMOTORY 6",8",10"



Průměr 6": 4,0 – 37,0 kW
 Průměr 8": 37,0 – 75,0 kW
 Průměr 10": 75,0 – 129,0 kW



MADE IN ITALY

Ponorné elektromotory s rotorem v olejové lázni. Připojení hydrauliky čerpadla dle normy NEMA (6" a 8").

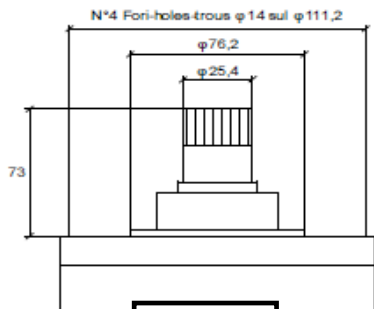

6"

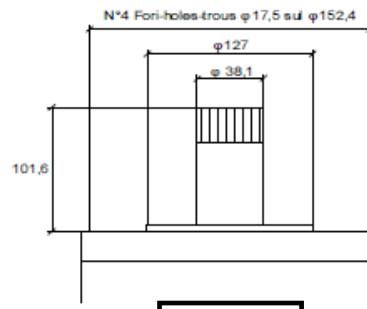

8"

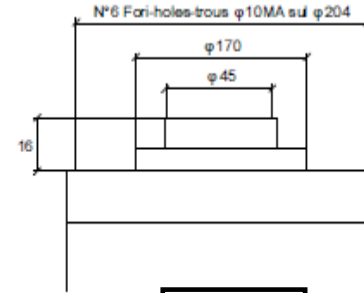

10"

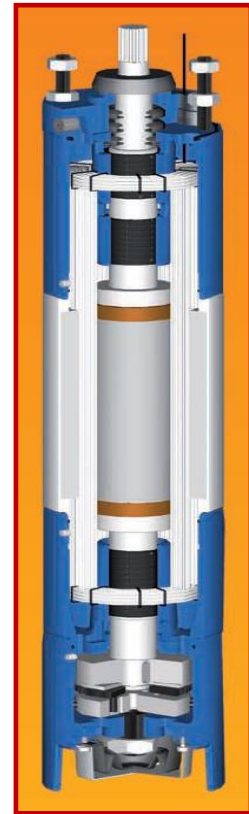

Příslušenství



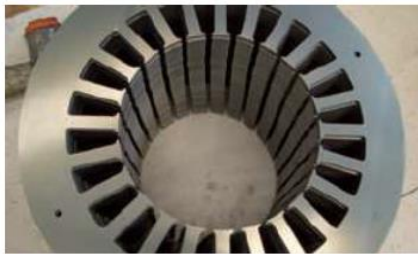

Děkujeme za Vaši pozornost



SIWATEC

čerpadla | pumps